



Thule Rooftop Tent Guidelines

Thule rooftop tents can be mounted on a wide range of vehicles and racks. To safely mount your rooftop tent, please read this document on vehicle and rack compatibility.

Vehicle Compatibility

To ensure your vehicle can support a rooftop tent, consider the following questions:

Can your vehicle's roof handle the weight of a rooftop tent?

Check your vehicle instruction manual or contact your local dealer to determine the weight limitations of your roof. These weight limitations will be the dynamic weight capacity* (the maximum weight permitted on the vehicle's roof while driving).

***Dynamic weight capacity = The weight capacity permitted while driving. Static weight capacity = Weight capacity of tent in use with people inside the tent when the vehicle is parked. Static weight can exceed dynamic weight. Each tent has a stated static weight capacity. As a guideline, the static weight capacity of Thule roof racks is 3x the dynamic weight capacity.**

Does your vehicle have a glass or large panoramic roof?

If so, make sure to ALWAYS check with your vehicle manufacturer to ensure that the roof can support the weight of a rooftop tent.

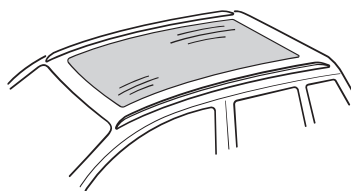

Does your vehicle have raised roof rails?

It is recommended to ONLY use a rooftop tent on raised rails that are supported.

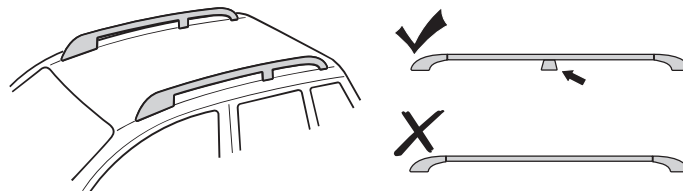

- Unsupported rails are usually too flexible to handle the static load of a tent with people inside.
- It is always recommended to position the rack crossbars as close to the support structure as possible to minimize flexing.

Rack Compatibility

To ensure your racks can support a rooftop tent, consider the following questions:

Can my roof rack system support the weight of a rooftop tent?

Roof racks have a maximum dynamic weight capacity. Double-check that the weight of the rooftop tent does not exceed the rack's maximum capacity.

Please note!

Thule Bars, Feet and Fit Kits may have different weight capacities. The component with the lowest weight capacity determines the rack system's maximum weight capacity.

Do I have a roof rack system that is from Thule?

We can only recommend Thule roof rack systems for our rooftop tents. For other roof rack brands or factory installed racks from your car manufacturer, please check the rack's manual to determine compatibility.

Do I have a compatible Thule roof rack system?

Thule rooftop tents are compatible with all Thule roof racks except the following:

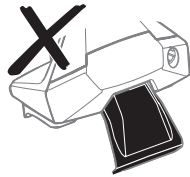

Thule roof rack systems that consist of Thule Evo Clamp or Thule Edge Clamp feet



All Thule Wingbar Edge Racks

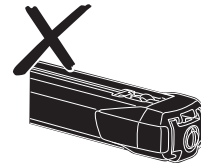

Thule SlideBar Crossbars

- The high static load of a tent with people inside using the above racks can cause damage to the rack and/or vehicle.

Is my rooftop tent mounting system compatible with the crossbars of my roof rack?

To correctly mount the tent to the crossbars of your roof rack, they need to have a specific height and width. Check the tent's instruction manual to confirm the mounting system is compatible with your crossbars.

Thule Approach / Thule Basin

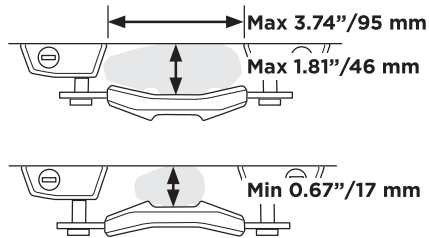

Thule Foothill / Thule Kukenam / Thule Autana

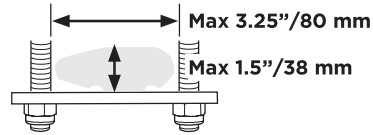

What is the front-to-back and side-to-side bar spread of your roof racks?

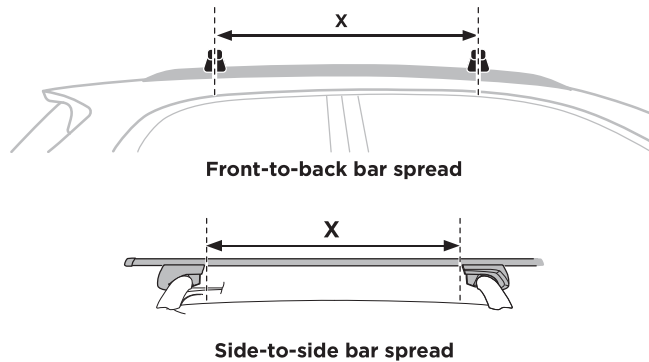

- The front-to-back bar spread for rooftop tents must be at least 28"/ 70cm to properly support a tent.
- The below table outlines the minimum side-to-side bar spread distance required for each tent*

Product Name	IN	CM
Thule Approach S	28	71
Thule Approach M / L	31	80
Thule Foothill	24	61
Thule Kukenam	34	85
Thule Autana 4	31	78
Thule Basin / Basin Wedge	32	81

*If your rack's side-to-side bar spread is less than the minimum requirement, the tent will need to be mounted outside of the roof rack's foot and must meet the conditions on the next page. This will result in the tent being slightly off-center on the vehicle.

□ **Is your rack's side-to-side bar spread less than the minimum requirement?**

- If so, one of the mounting rails must be mounted outside of the rack's foot.
- The tent's mounting rail must be mounted within 2.5cm/1" of the rack's foot **A**.
- There is a 2 cm metal roof rack crossbar outside of the tent mounting system **B**.

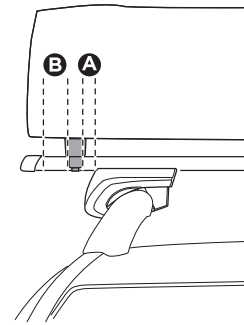

Please note!

The Vehicle Selector tool on Thule.com does not consider the bar spread of your vehicle so please measure your rack's bar spread to ensure compatibility.