





# JETSTREAM CROSSBAR WITH BASELINE MOUNT

## SSANGYONG MUSSO 4 DOOR UTE 2019 - (NAKED ROOF)

### MEASUREMENTS

 <b>M1</b>	<b>Front Crossbar</b> Inner edge of driver's side leg to inner edge of passenger's side leg	<b>1045 mm</b>	 <b>M3</b>	<b>Rear Crossbar</b> Inner edge of driver's side leg to inner edge of passenger's side leg	<b>1025 mm</b>
 <b>M2</b>	<b>Front Crossbar</b> Corner of painted or glass roof to leading edge of front pad or foot	<b>200 mm</b>	 <b>M4</b>	<b>Crossbar Spread</b> Rear edge of front crossbar to rear edge of rear crossbar.	<b>815 mm</b>

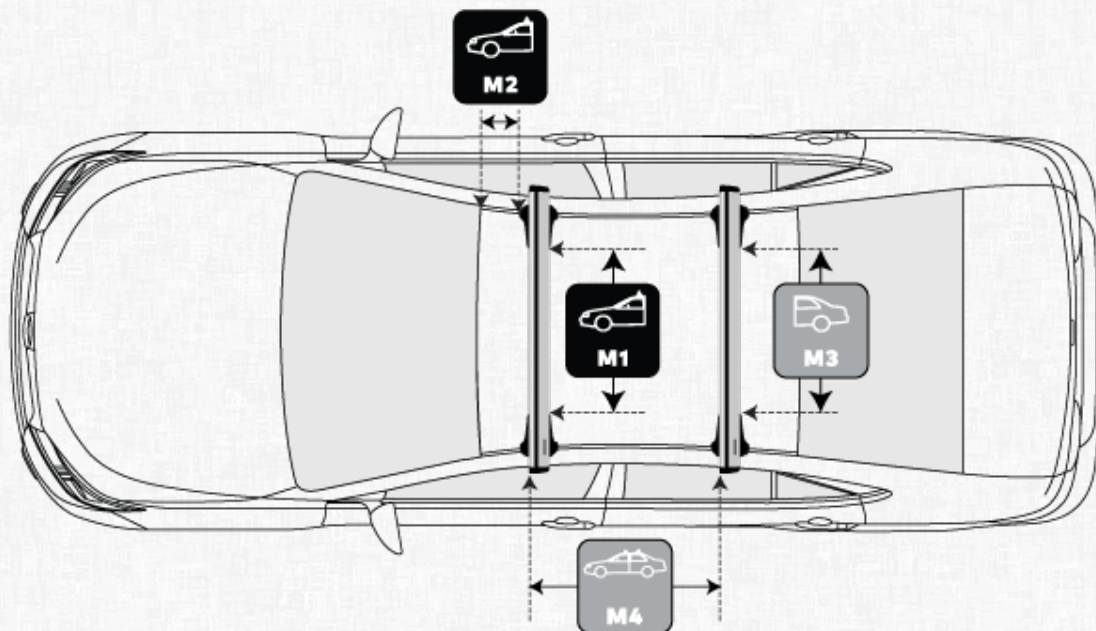

### PITCH SETTINGS



### Pitch 1

Adjustment on the front legs to help keep the crossbars level

B



### Pitch 2

Adjustment on the rear legs to help keep the crossbars level

B

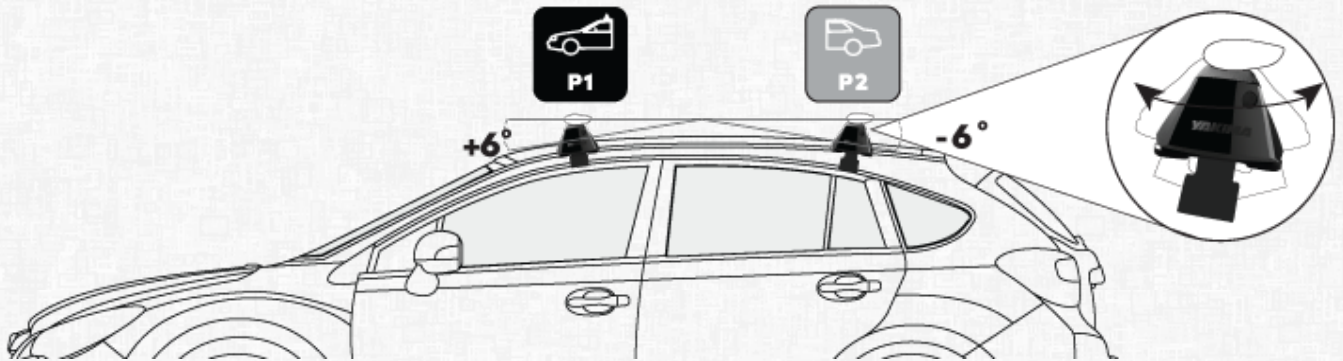

## TOE SETTINGS



### Front Toe Setting

Adjustment on the front legs to keep legs and crossbars perpendicular to the vehicle

2



### Rear Toe Setting

Adjustment on the rear legs to keep legs and crossbars perpendicular to the vehicle

2

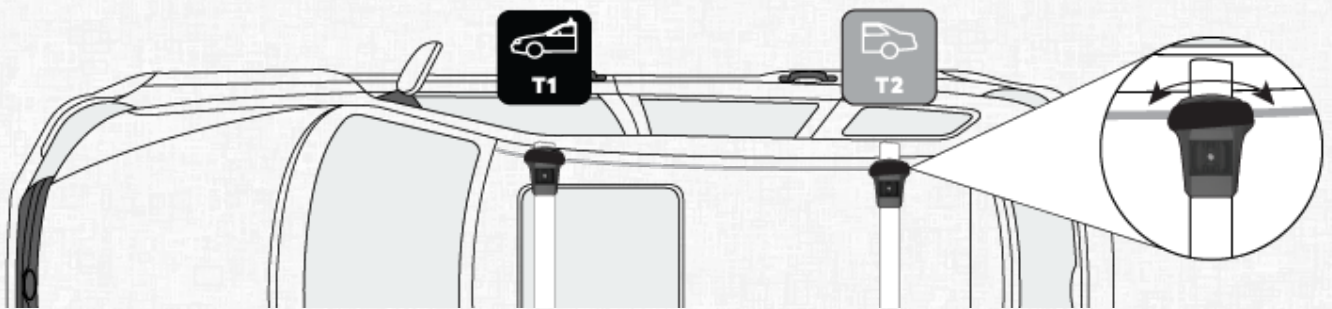

## BASE CLIP DETAILS



### Front Product

Name of BaseClip product required for front bar

BC129



### Rear Product

Name of BaseClip product required for rear bar

BC129



### Front Pad



### Rear Pad



Number on the pads  
required for the front bar

**5**



Number on the pads  
required for the rear bar

**5**



**Front Clip Number**

Number on the clips  
required for the front bar

**B58**



**Rear Clip Number**

Number on the clips  
required for the rear bar

**B58**

---

UK-150842-278114