





# JETSTREAM CROSSBAR WITH BASELINE MOUNT

## TOYOTA YARIS 5 DOOR HATCH 2020 - (NAKED ROOF)

### MEASUREMENTS

 <b>M1</b>	<b>Front Crossbar</b> Inner edge of driver's side leg to inner edge of passenger's side leg	<b>790 mm</b>	 <b>M3</b>	<b>Rear Crossbar</b> Inner edge of driver's side leg to inner edge of passenger's side leg	<b>745 mm</b>
 <b>M2</b>	<b>Front Crossbar</b> Corner of painted or glass roof to leading edge of front pad or foot	<b>230 mm</b>	 <b>M4</b>	<b>Crossbar Spread</b> Rear edge of front crossbar to rear edge of rear crossbar.	<b>730 mm</b>

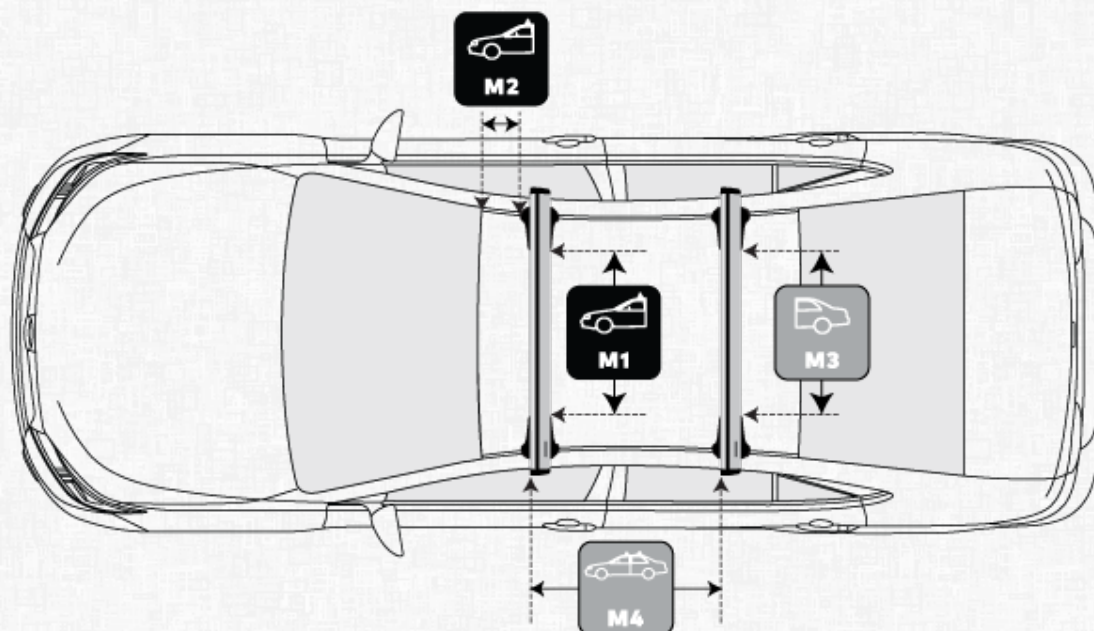

### PITCH SETTINGS



### Pitch 1

Adjustment on the front legs to help keep the crossbars level

A



### Pitch 2

Adjustment on the rear legs to help keep the crossbars level

C

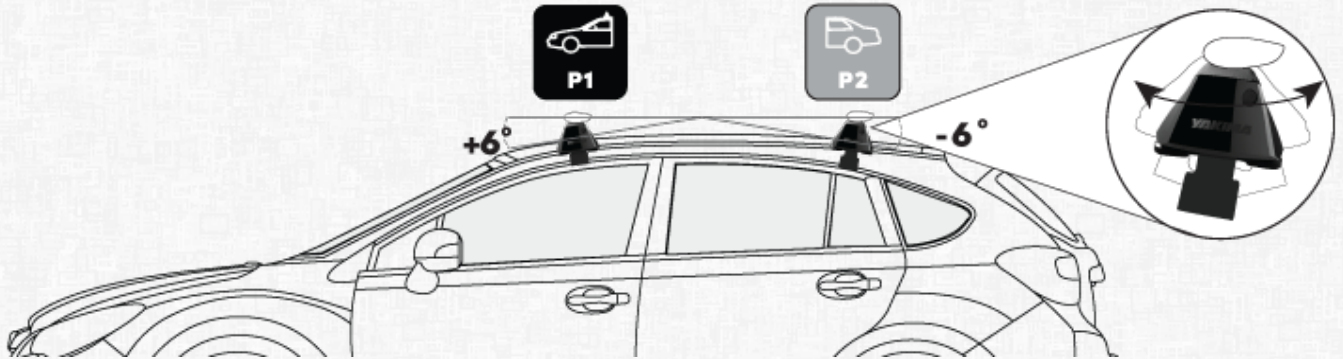

## TOE SETTINGS



### Front Toe Setting

Adjustment on the front legs to keep legs and crossbars perpendicular to the vehicle

1



### Rear Toe Setting

Adjustment on the rear legs to keep legs and crossbars perpendicular to the vehicle

2

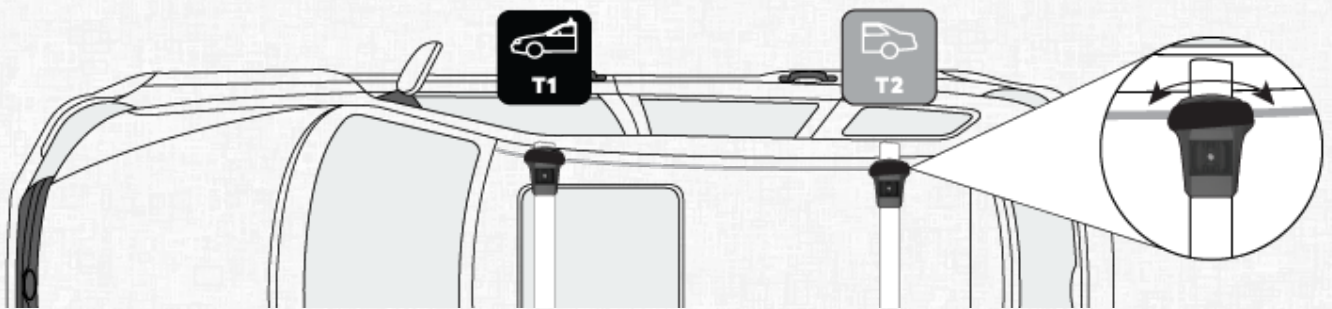

## BASE CLIP DETAILS



### Front Product

Name of BaseClip product required for front bar

BC144



### Rear Product

Name of BaseClip product required for rear bar

BC144



### Front Pad



### Rear Pad



Number on the pads  
required for the front bar

**5**



Number on the pads  
required for the rear bar

**5**



**Front Clip Number**

Number on the clips  
required for the front bar

**B57**



**Rear Clip Number**

Number on the clips  
required for the rear bar

**B57**

---

UK-151304-278157