





JETSTREAM CROSSBAR WITH BASELINE MOUNT

HYUNDAI IONIQ 5 DOOR HATCH 2017 - (NAKED ROOF)

MEASUREMENTS

 M1	Front Crossbar Inner edge of driver's side leg to inner edge of passenger's side leg	958 mm	 M3	Rear Crossbar Inner edge of driver's side leg to inner edge of passenger's side leg	958 mm
 M2	Front Crossbar Corner of painted or glass roof to leading edge of front pad or foot	203 mm	 M4	Crossbar Spread Rear edge of front crossbar to rear edge of rear crossbar.	812 mm

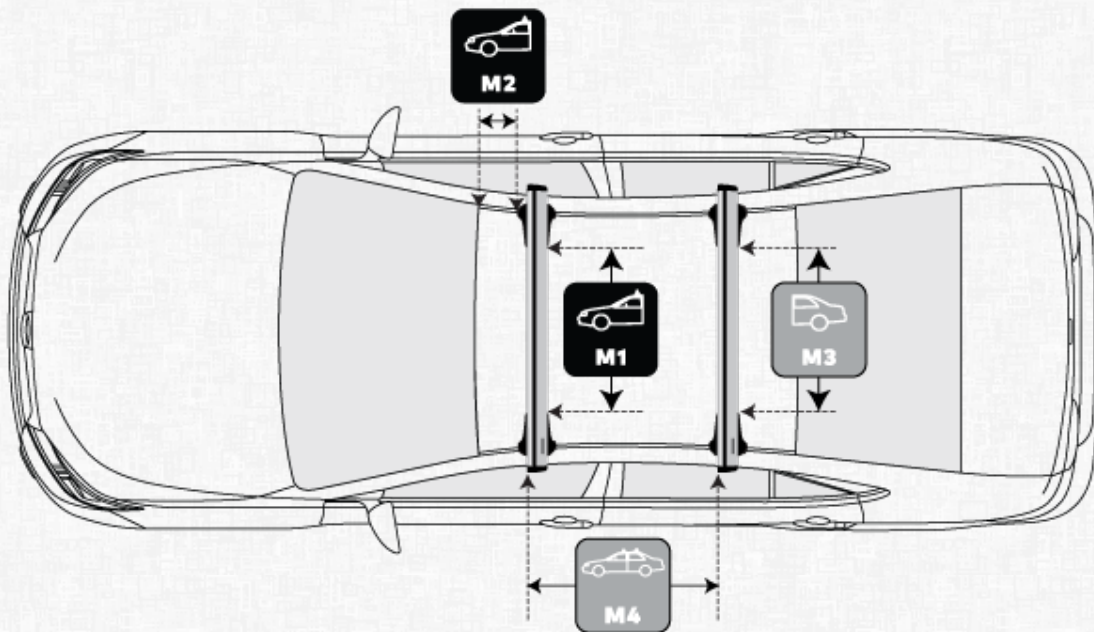

PITCH SETTINGS



Pitch 1

Adjustment on the front legs to help keep the crossbars level

A



Pitch 2

Adjustment on the rear legs to help keep the crossbars level

C

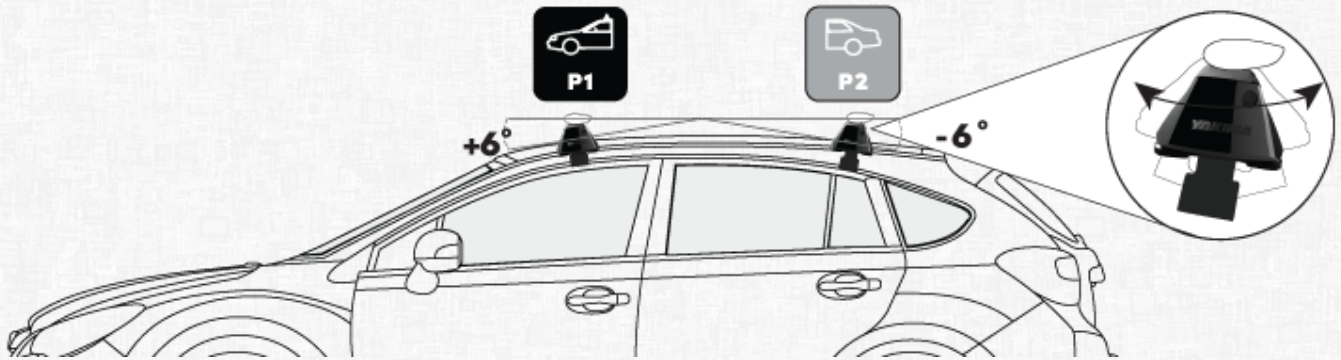

TOE SETTINGS



Front Toe Setting

Adjustment on the front legs to keep legs and crossbars perpendicular to the vehicle

1



Rear Toe Setting

Adjustment on the rear legs to keep legs and crossbars perpendicular to the vehicle

2

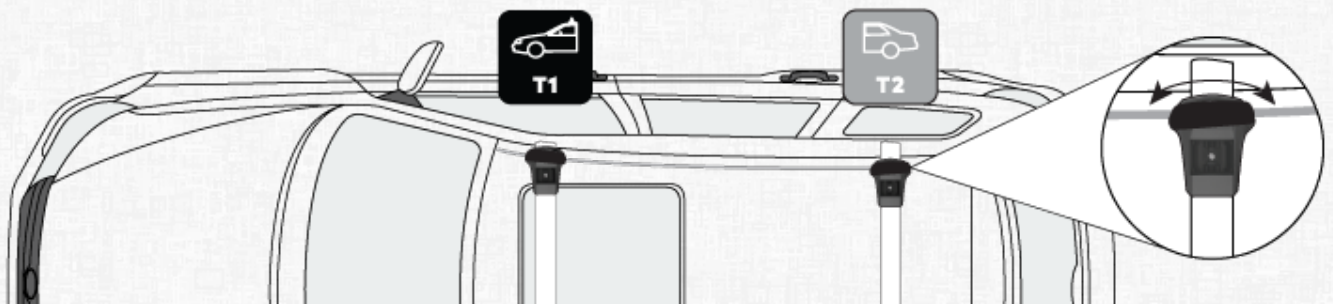

BASE CLIP DETAILS



Front Product

Name of BaseClip product required for front bar

BC175



Rear Product

Name of BaseClip product required for rear bar

BC111



Front Pad

Number on the pads
required for the front bar

4



Rear Pad

Number on the pads
required for the rear bar

3



Front Clip Number

Number on the clips
required for the front bar

B85



Rear Clip Number

Number on the clips
required for the rear bar

B36

UK-150796-277961