





JETSTREAM CROSSBAR WITH SKYLINE MOUNT

SUBARU IMPREZA 5 DOOR HATCH 2017 - (NAKED ROOF)

MEASUREMENTS

 M1	Front Crossbar Inner edge of driver's side leg to inner edge of passenger's side leg	933 mm	 M3	Rear Crossbar Inner edge of driver's side leg to inner edge of passenger's side leg	885 mm
 M2	Front Crossbar Corner of painted or glass roof to leading edge of front pad or foot	N/A	 M4	Crossbar Spread Rear edge of front crossbar to rear edge of rear crossbar.	793 mm

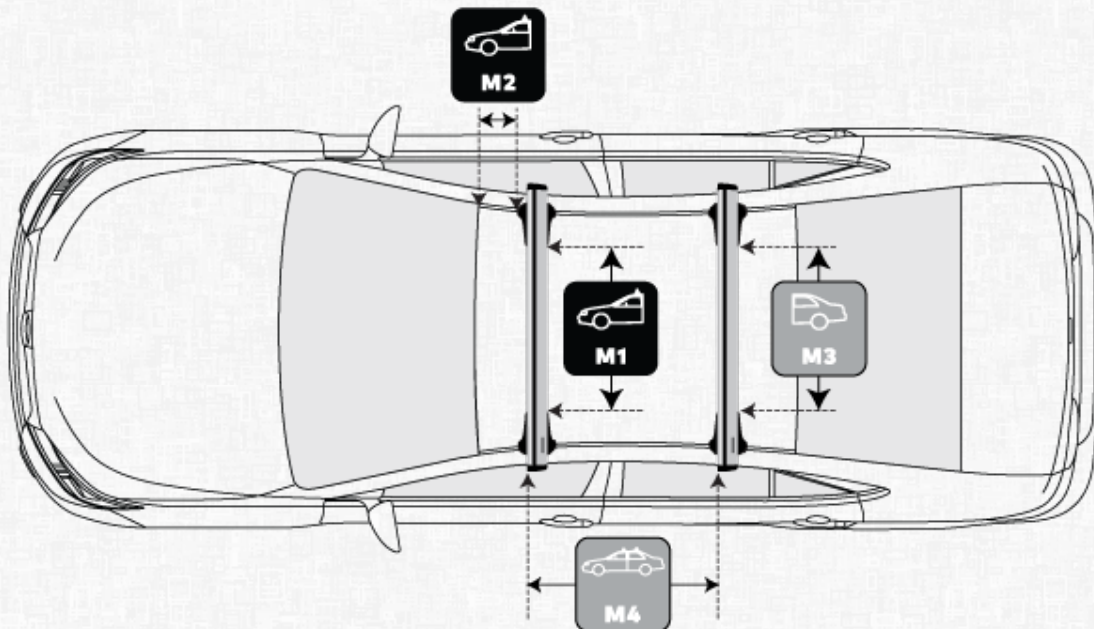

PITCH SETTINGS



Pitch 1

Adjustment on the front legs to help keep the crossbars level

A



Pitch 2

Adjustment on the rear legs to help keep the crossbars level

C

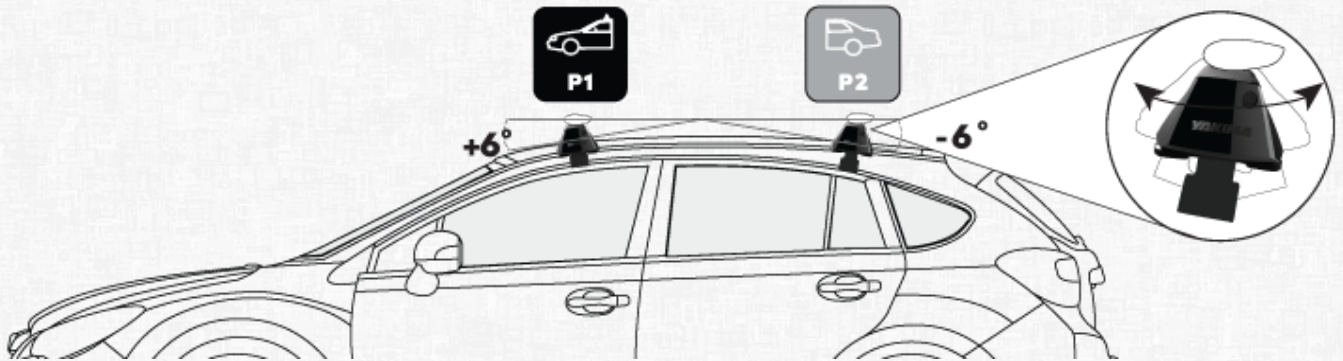

LANDING PAD DETAILS (LP22)



Pad Type

Part number to indicate which pad shape to use

5023013



Front Bolts

Which bolts from the pack are required to secure the front bar

M6x28 mm



Pad Orientation

Indicates which way to place the pads on the vehicle

Arrow
OUT
<||>



Mid Bolts (3 Bar Fits only)

Which bolts from the pack are required to secure middle bar in 3 bar fits

N/A

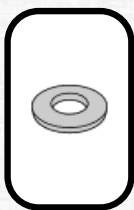

Washer

Washers to be used on each bolt to secure the bar/s

M6



Rear Bolts

Which bolts from the pack are required to secure the rear bar

M6x28 mm