





# JETSTREAM CROSSBAR WITH SKYLINE MOUNT

## BMW 5 SERIES G30 4 DOOR SEDAN 2017

### MEASUREMENTS

|   |  |               |   |   |               |
|---|--|---------------|---|---|---------------|
| <br><b>M1</b>  | <b>Front Crossbar</b><br>Inner edge of driver's side leg to inner edge of passenger's side leg | <b>946 mm</b> | <br><b>M3</b>  | <b>Rear Crossbar</b><br>Inner edge of driver's side leg to inner edge of passenger's side leg | <b>900 mm</b> |
| <br><b>M2</b> | <b>Front Crossbar</b><br>Corner of painted or glass roof to leading edge of front pad or foot  | <b>N/A</b>    | <br><b>M4</b> | <b>Crossbar Spread</b><br>Rear edge of front crossbar to rear edge of rear crossbar.          | <b>770 mm</b> |

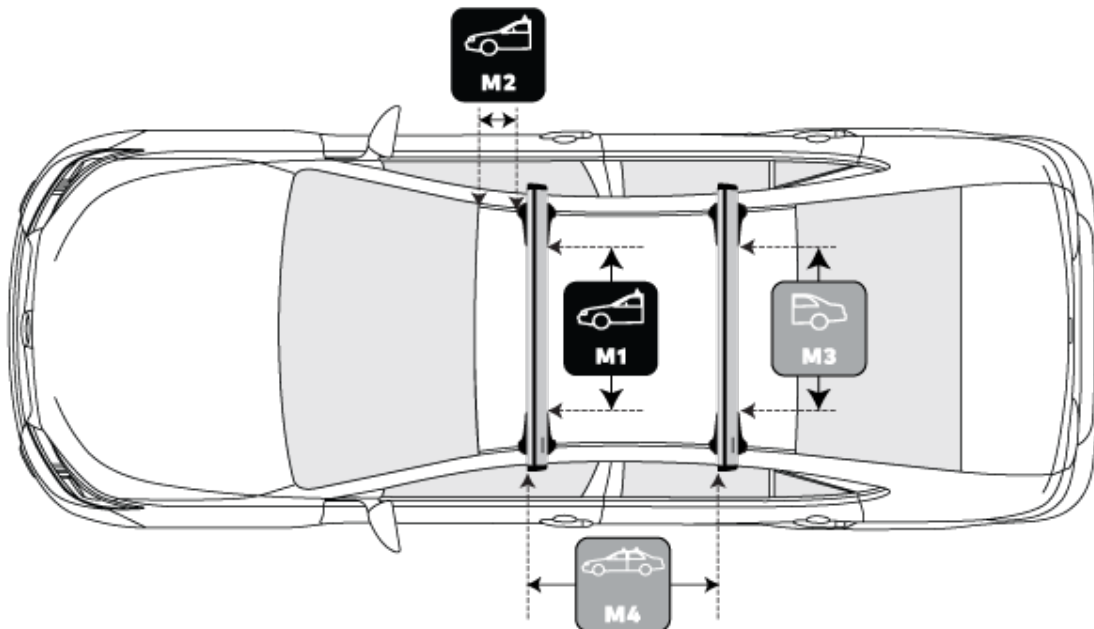

### PITCH SETTINGS



### Pitch 1

Adjustment on the front legs to help keep the crossbars level

**A**



### Pitch 2

Adjustment on the rear legs to help keep the crossbars level

**C**

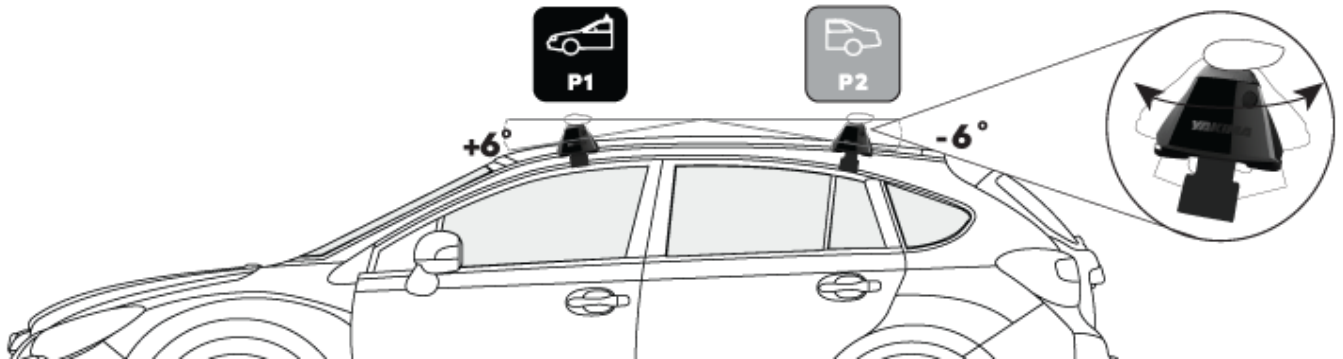

## LANDING PAD DETAILS (LP25)



### Pad Type

Part number to indicate which pad shape to use

**5023012**

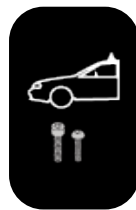

### Front Bolts

Which bolts from the pack are required to secure the front bar

**M7x50 mm**



### Pad Orientation

Indicates which way to place the pads on the vehicle

**Arrow  
OUT  
<||>**



### Mid Bolts (3 Bar Fits only)

Which bolts from the pack are required to secure middle bar in 3 bar fits

**N/A**

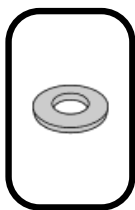

### Washer

Washers to be used on each bolt to secure the bar/s

**M7**



### Rear Bolts

Which bolts from the pack are required to secure the rear bar

**M7x50 mm**