





# JETSTREAM CROSSBAR WITH SKYLINE MOUNT

## BMW 2 SERIES 2 DOOR COUPE 2022

### MEASUREMENTS

 <b>M1</b>	<b>Front Crossbar</b> Inner edge of driver's side leg to inner edge of passenger's side leg	<b>845 mm</b>	 <b>M3</b>	<b>Rear Crossbar</b> Inner edge of driver's side leg to inner edge of passenger's side leg	<b>855 mm</b>
 <b>M2</b>	<b>Front Crossbar</b> Corner of painted or glass roof to leading edge of front pad or foot	<b>N/A</b>	 <b>M4</b>	<b>Crossbar Spread</b> Rear edge of front crossbar to rear edge of rear crossbar.	<b>770 mm</b>

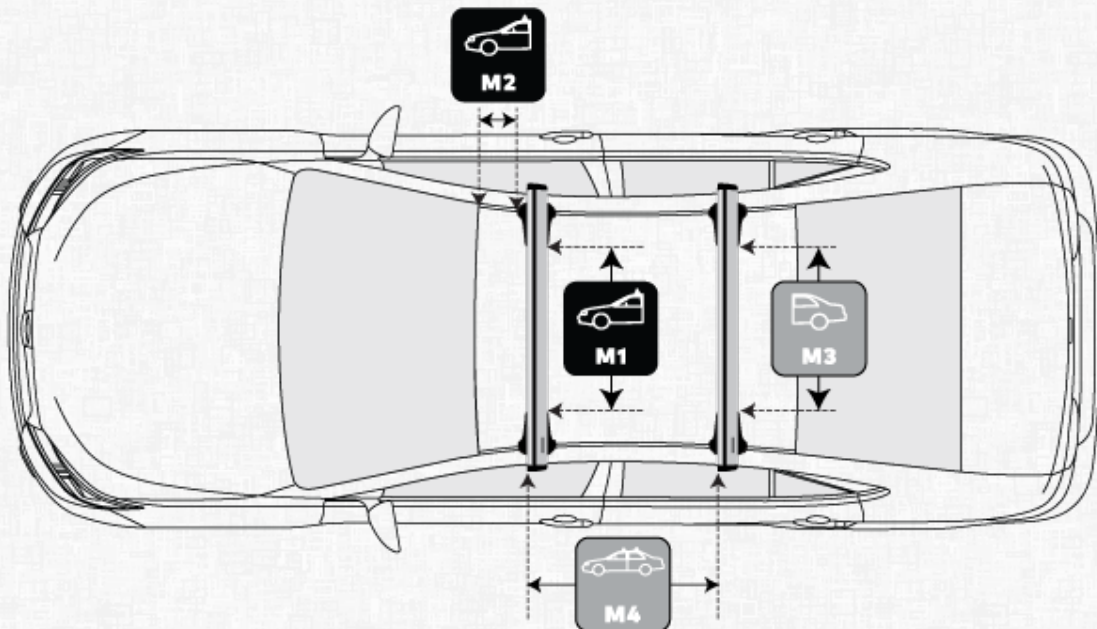

### PITCH SETTINGS



### Pitch 1

Adjustment on the front legs to help keep the crossbars level

A



### Pitch 2

Adjustment on the rear legs to help keep the crossbars level

C

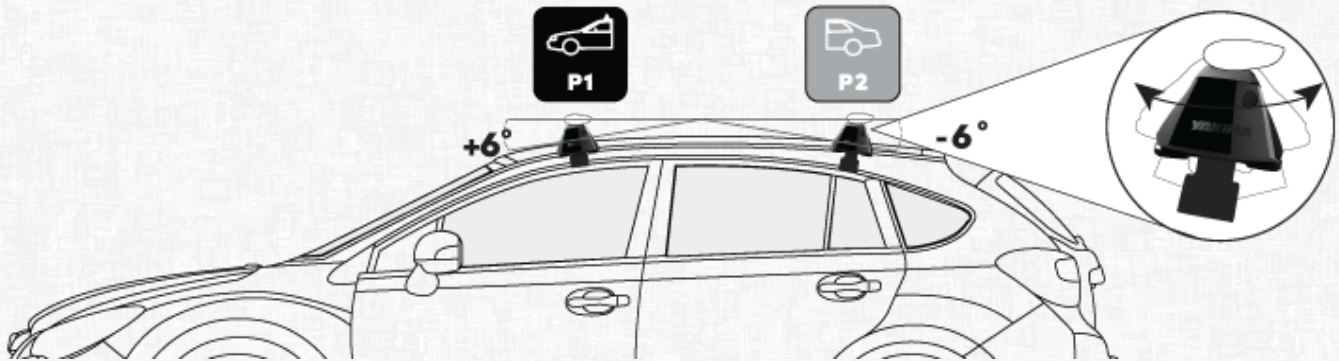

## LANDING PAD DETAILS (LP25)



### Pad Type

Part number to indicate which pad shape to use

5023012



### Front Bolts

Which bolts from the pack are required to secure the front bar

M7x30 mm

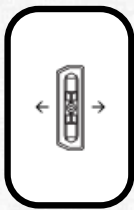

### Pad Orientation

Indicates which way to place the pads on the vehicle

Arrow  
OUT  
<||>



### Mid Bolts (3 Bar Fits only)

Which bolts from the pack are required to secure middle bar in 3 bar fits

N/A

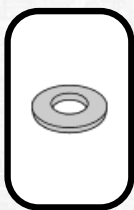

### Washer

Washers to be used on each bolt to secure the bar/s

M7



### Rear Bolts

Which bolts from the pack are required to secure the rear bar

M7x30 mm